

# **MSHA's Guide to Equipment Guarding**



---

U.S. Department of Labor  
Elaine L. Chao  
Secretary

Other Training Material  
OT 3

Revised 2004

## **INTRODUCTION**

This guide is provided to assist the mining community with designing, installing and maintaining equipment guards to prevent miners from contacting hazardous moving machine parts. Contact with machine parts may result in serious accidents or death. Proper equipment guarding is essential to reduce this risk of injury.

This guide provides examples of commonly used point-of-contact guards which are guards for individual hazards and area guards which are guards for individual or multiple hazards. These examples are intended for guidance only and alternate designs may be acceptable if the relevant MSHA guarding standards are met.

## **TRAINING**

Miners need to understand the types of guards and systems at the mine. Specific training is a crucial part of any effective equipment guarding system. Training should involve instruction and/or hands-on training in the following:

- ✓ Identify and describe the hazards associated with specific equipment.
- ✓ How do the equipment guards provide protection for this specific equipment.
- ✓ How, and under what circumstances, can the equipment guards be safely removed and when must the equipment guards be replaced.
- ✓ What to do if an equipment guard is damaged or missing.

This kind of safety training is necessary for new miners and maintenance personnel. Additional training or retraining is necessary when changes are made to guarding systems. Training may be required when miners are assigned to different equipment and/or locations.

## **Guarding Considerations and Recommendations**

*This section is written as a brief discussion of effective guard design and use and is not a requirement for compliance.*

The input and ideas of miners, equipment manufacturers, machine operators, maintenance personnel, and supervisors can enhance the design, construction and installation of equipment guards.

- ◆ Do the design, construction, selection of materials and guard installation prevent contact with all moving machine part hazards?
- ◆ Does the guard provide protection by itself, and not rely on visual or tactile awareness of a hazard, administrative controls or procedures such as warnings, signs, lights, training, supervision or personal protective equipment?
- ◆ Are the guard material(s), fastening methods, and construction suitable to withstand the wear, corrosion, vibration and shock of normal operations?
- ◆ If drive belts inside a guard fail, will the whipping action of broken belts be contained?
- ◆ Is the guard recognizable as a guard?
- ◆ Is the guard installed securely?
- ◆ Is the guard design adequate for the application and specific hazard(s)?
- ◆ Are openings in the guard material such that contact with the hazard is prevented by the distance between the guard and the hazard?
- ◆ Does the guard interfere with the normal operation, inspection, lubrication or servicing of the equipment?
- ◆ Is the guard designed and constructed so that adjustments to the guarded components can be made without loss of protection or modifying the guard?

- ◆ Do the design, materials and guard construction prevent the guard from being a hazard itself (i.e., free of burrs, sharp edges, pinch points, etc.)?
- ◆ Is the guard of a size, shape, weight and balance which permits safe manual handling when it is removed or replaced? Alternately, if it is too large for manual handling, is it accessible and amenable for safe handling with mechanical tools or equipment?
- ◆ Is the guard constructed so that it cannot be circumvented, by-passed or overcome?
- ◆ Can the guarded components be inspected without removing the guard?
- ◆ Is the guard constructed and located so as not to hinder clean-up efforts?
- ◆ Is the guard maintained in serviceable condition?
- ◆ Have you considered the use of new technology, if applicable?

**Many of the illustrations contained in this guide-book show the use of expanded metal. MSHA requirements are based on the level of protection provided, not the choice of materials for guard construction.**

Figure 1 shows an inadequate conveyor tail pulley guard. The rear and top of the pulley are fully exposed providing access to moving machine parts.

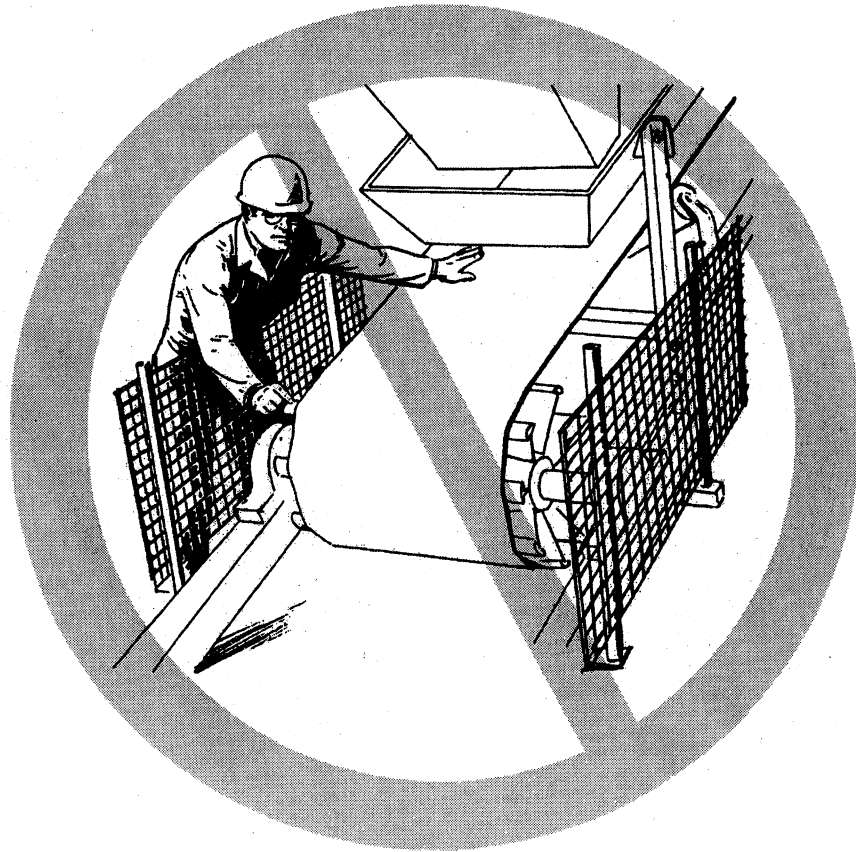

**Figure 1**

The guard in Figure 2 covers the pinch point and the moving parts of the tail pulley. If properly maintained, this design can prove effective in preventing contact during work-related activities.

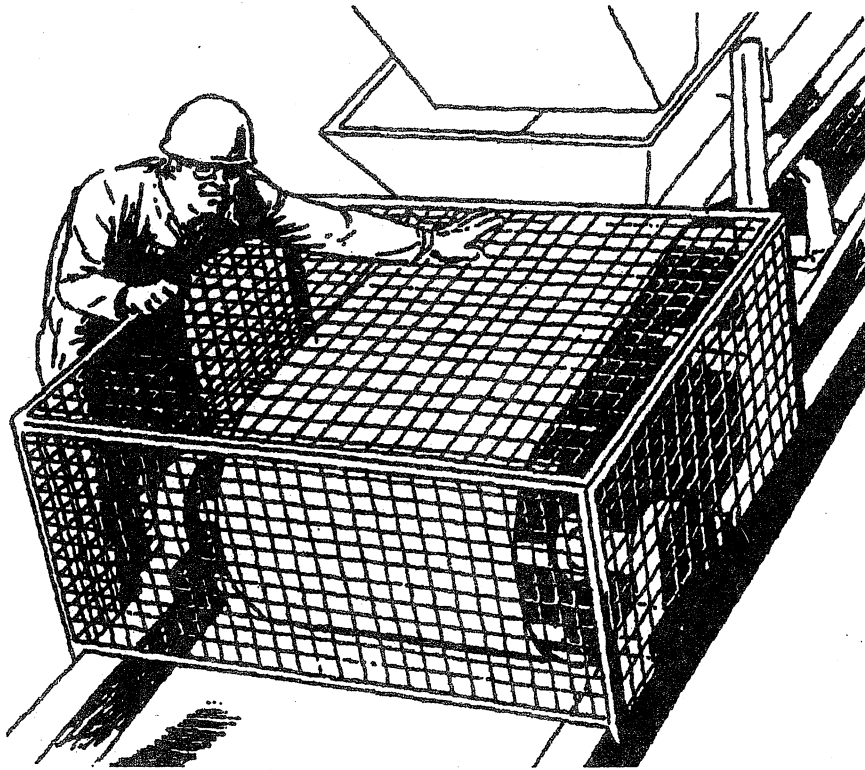

Figure 2

Figure 3 shows an elevated tail pulley. Because the underside of the pulley is accessible, it needs to be guarded. The guard may have openings large enough to allow fines to fall through, but not large enough to allow a miner to reach the moving machine parts.

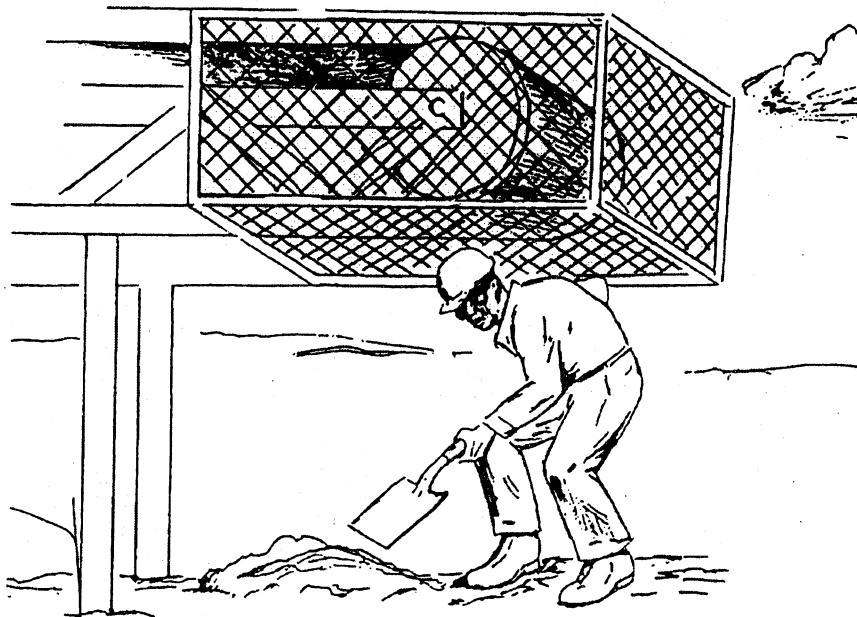

Figure 3



The reason for guarding return idlers is shown in Figure 4.

Return idlers should be guarded wherever miners could contact them. Guarding return idlers may be required where miners work or travel beneath the belt.

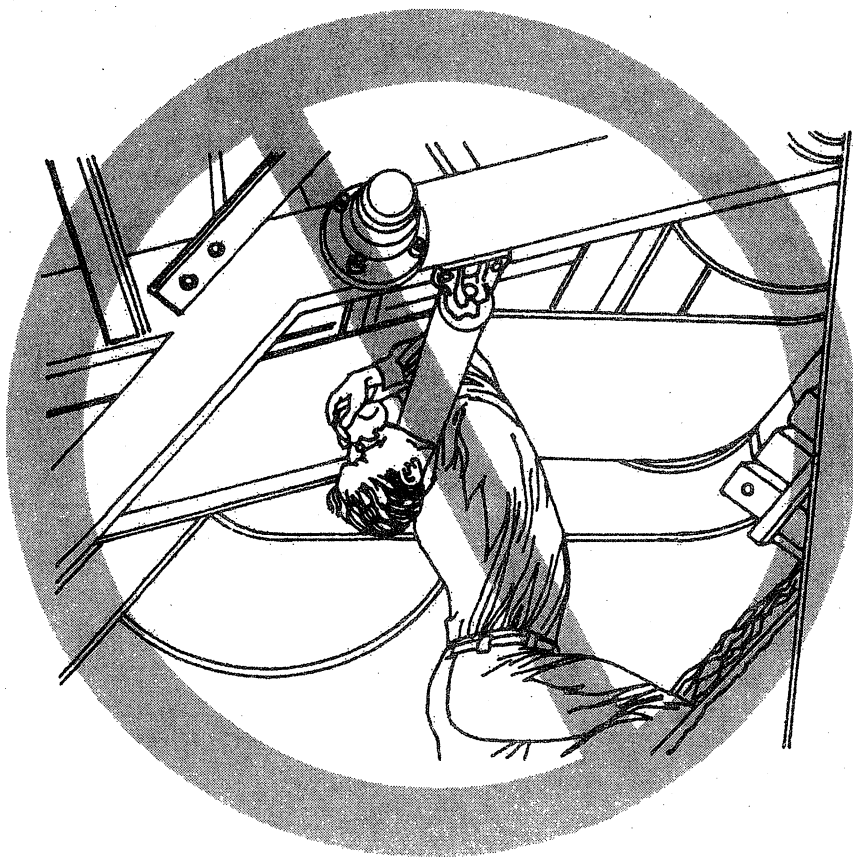

Figure 4

If return idlers require guarding, the figures below show three examples of guards for return idlers. Notice that the grease fittings can be accessed without removing the guard. The guards may have openings large enough to allow fines to fall through, but not large enough to allow a miner to reach the moving machine parts.

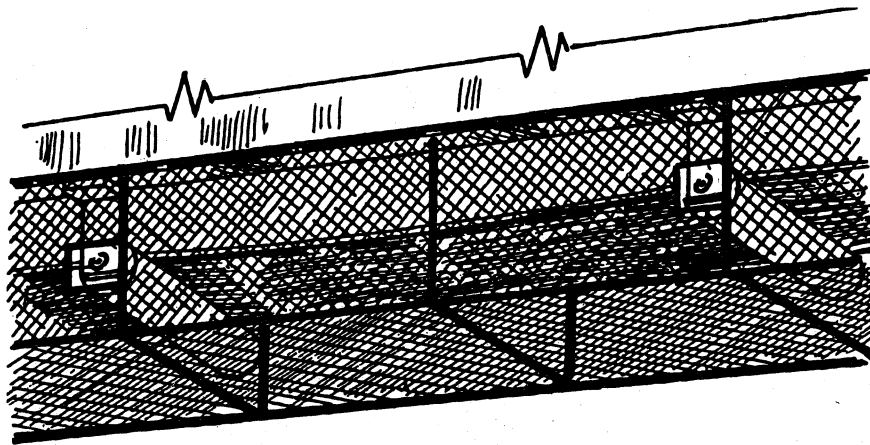

Figure 5

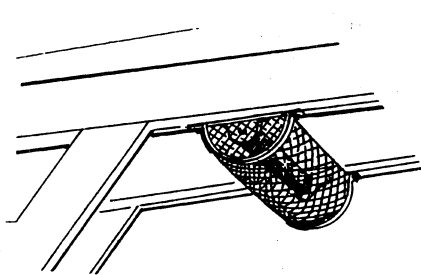

Figure 6

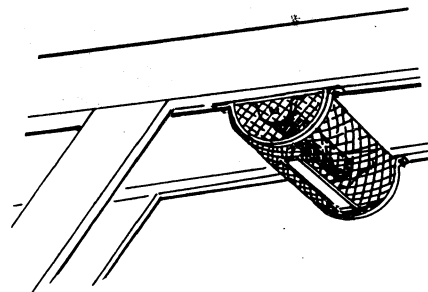
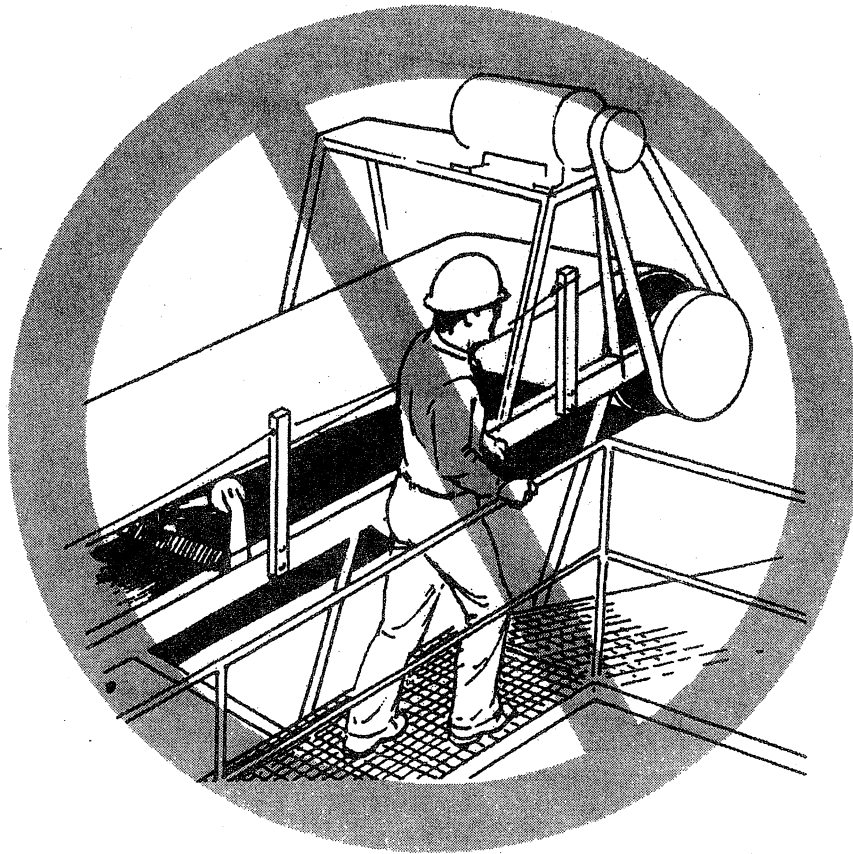

Figure 7

An unguarded head pulley and drive unit are shown in Figure 8. The conveyor pulley, drive pulleys, and belts are exposed, allowing access to hazards.



**Figure 8**

The head pulley and drive guards in Figure 9 are constructed to protect the miner from the pinch points, drive shafts and V-belts.

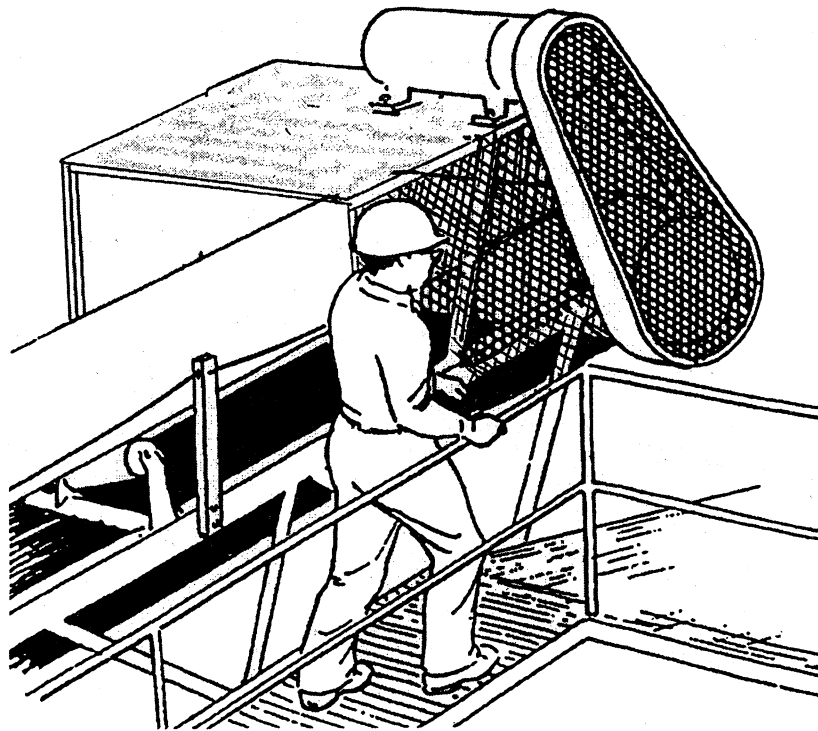

Figure 9

Unguarded conveyors next to travelways must be equipped with emergency stop cords (FOR METAL/NONMETAL ONLY: a railing is an acceptable alternative to a stop cord).

The emergency stop cord must be sufficiently tight to assure the conveyor drive motor will be deactivated when the cord is pulled. There is no specific location required for the stop cord; however, it should be located so that a person falling on or against the conveyor can activate the stop cord.

Figure 10 shows an emergency stop cord along a conveyor belt with a walkway.

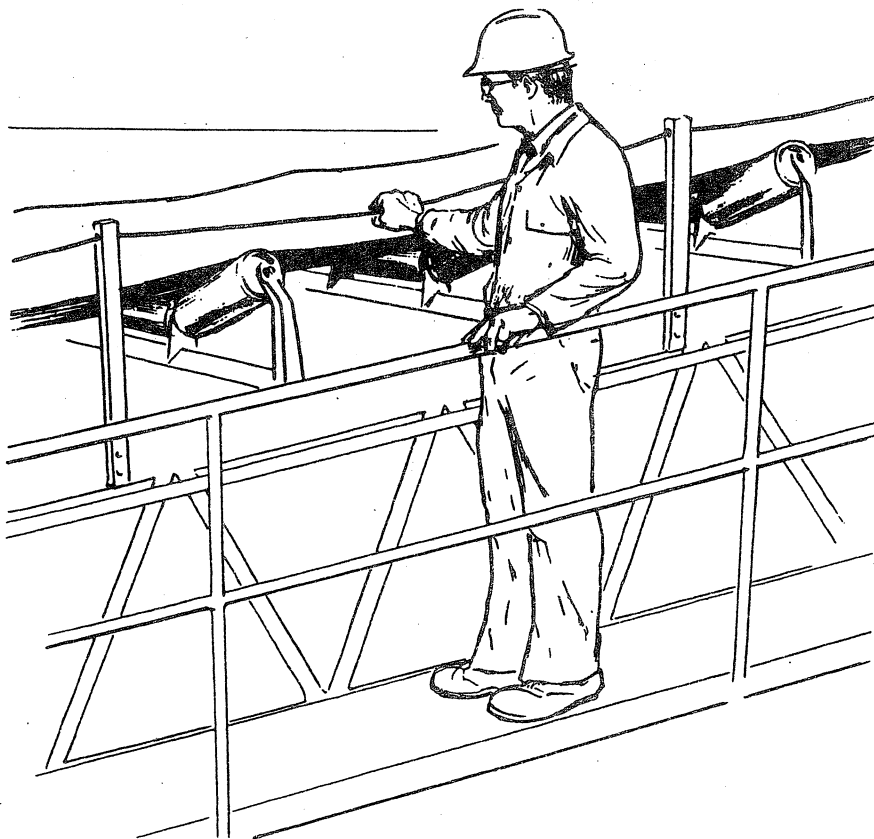
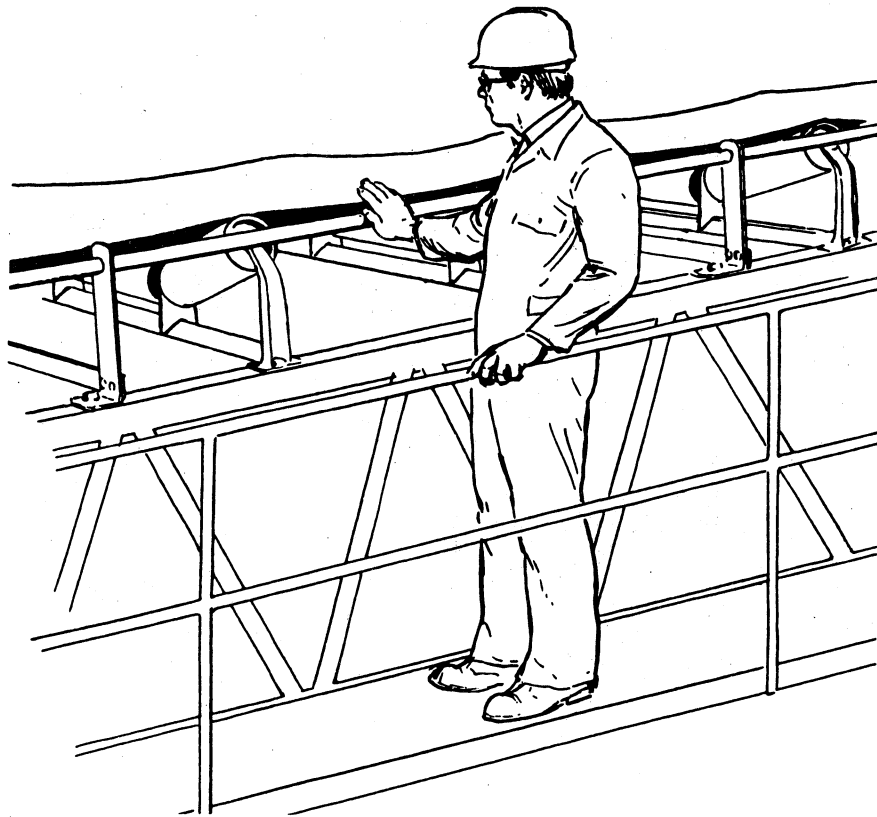

Figure 10

## **FOR METAL & NONMETAL ONLY**

Figure 11 shows a railing installed along the conveyor in lieu of an emergency stop cord. The railing is positioned to prevent persons from falling on or against the conveyor.



**Figure 11**

Figure 12 shows an unguarded take-up pulley system. The figure shows exposed bend pulleys and a take-up pulley which can easily be contacted. This conveyor structure does not provide a sufficient guard.



Figure 12

Guards can be installed to prevent access to the take-up pulleys (Figure 13). The guard needs to prevent access to pinch points and moving machine parts.

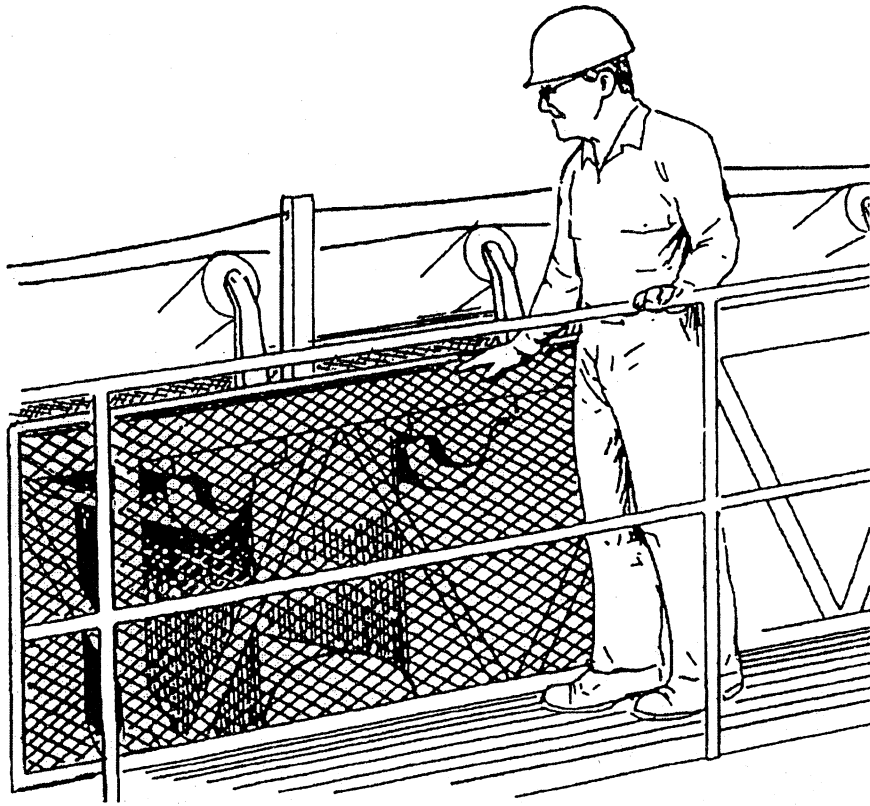

**Figure 13**



The moving machine parts of take-up pulleys are often located a sufficient distance above the ground to prevent contact, and are therefore considered "guarded by location." They may be equipped with heavy counterweights that pose a suspended load hazard. Precautions such as a barricade, railings or a guard (Figure 14) should be taken to prevent access below the suspended load. An acceptable alternative for some counterweights would be the use of wire ropes to prevent dropping hazards.

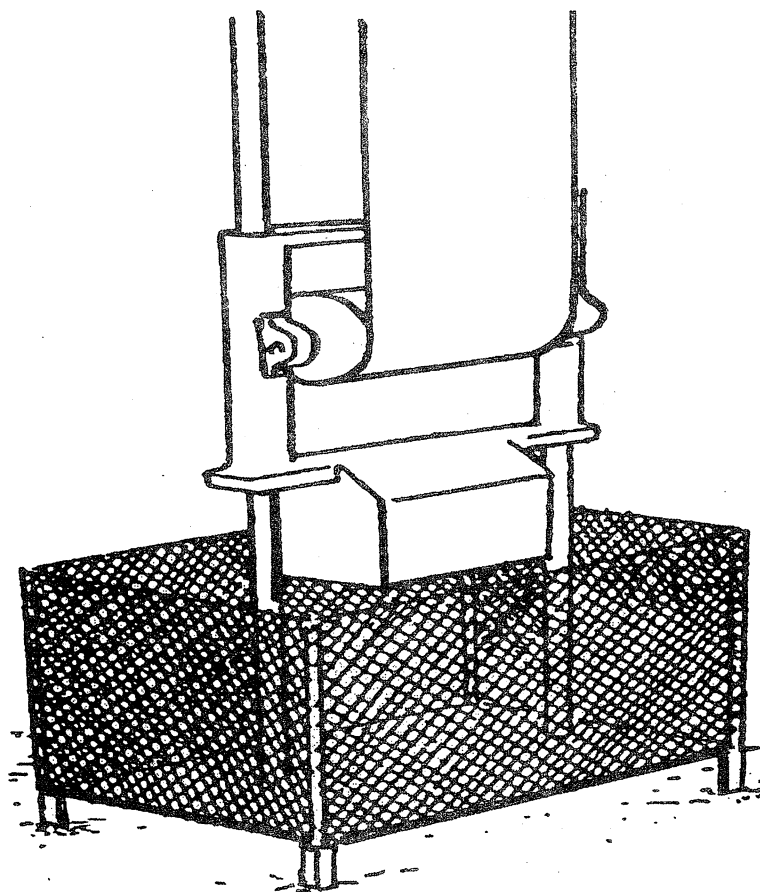
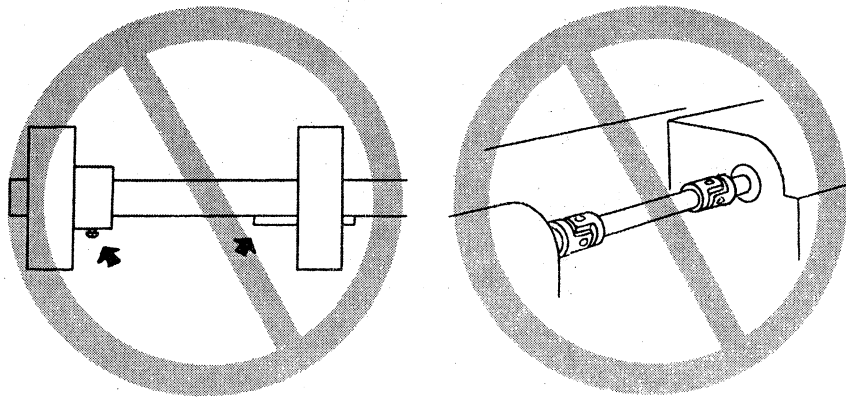
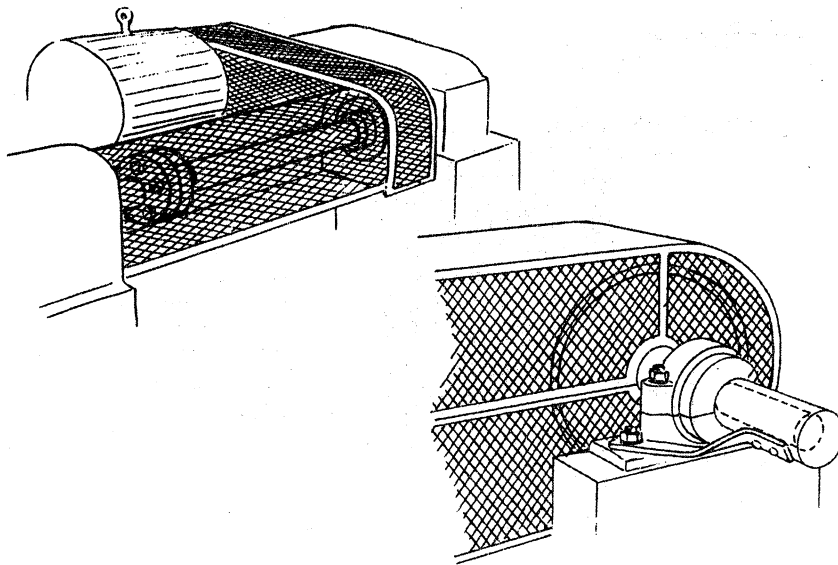

Figure 14

Shafts and shaft ends need guarding if they present a hazard. Rotation speed, size, location, keyways, burrs and other factors need to be considered when determining which shafts need guarding. Not all shafts and shaft ends require guarding. The examples shown in Figure 15 contain protruding bolts, keys, and couplings and should be guarded. Figure 16 shows examples of guards for rotating shafts and shaft ends.



**Figure 15**



**Figure 16**

Figure 17 shows a drive coupling. Couplings need to be enclosed to prevent contact. An example guard is shown in Figure 18.

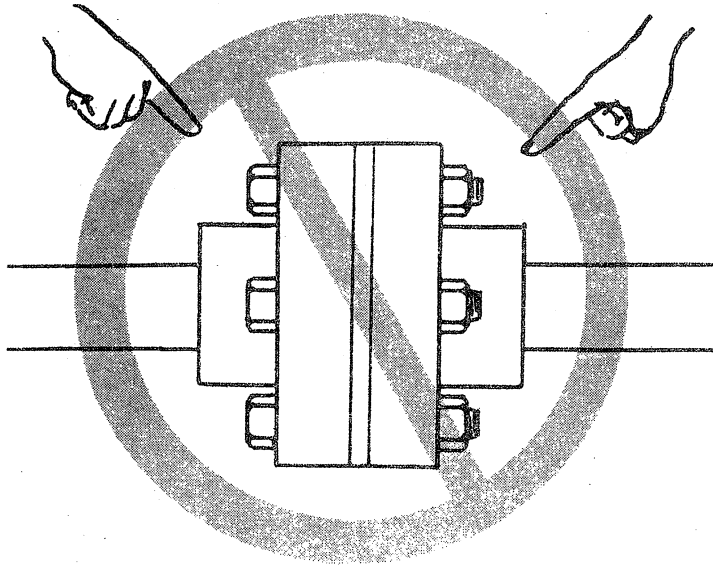

Figure 17

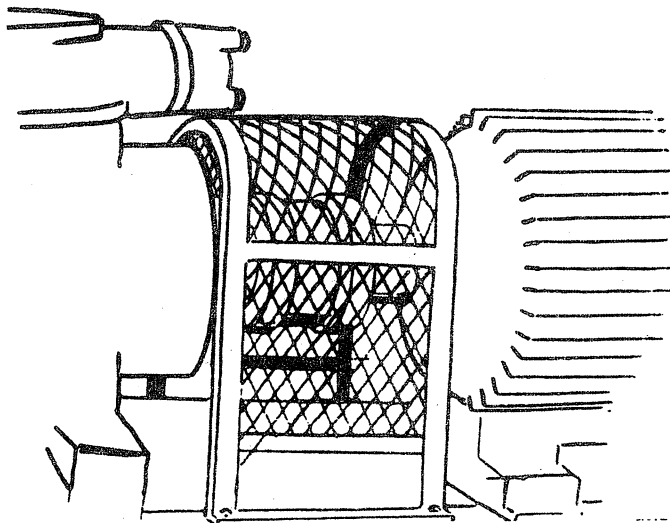
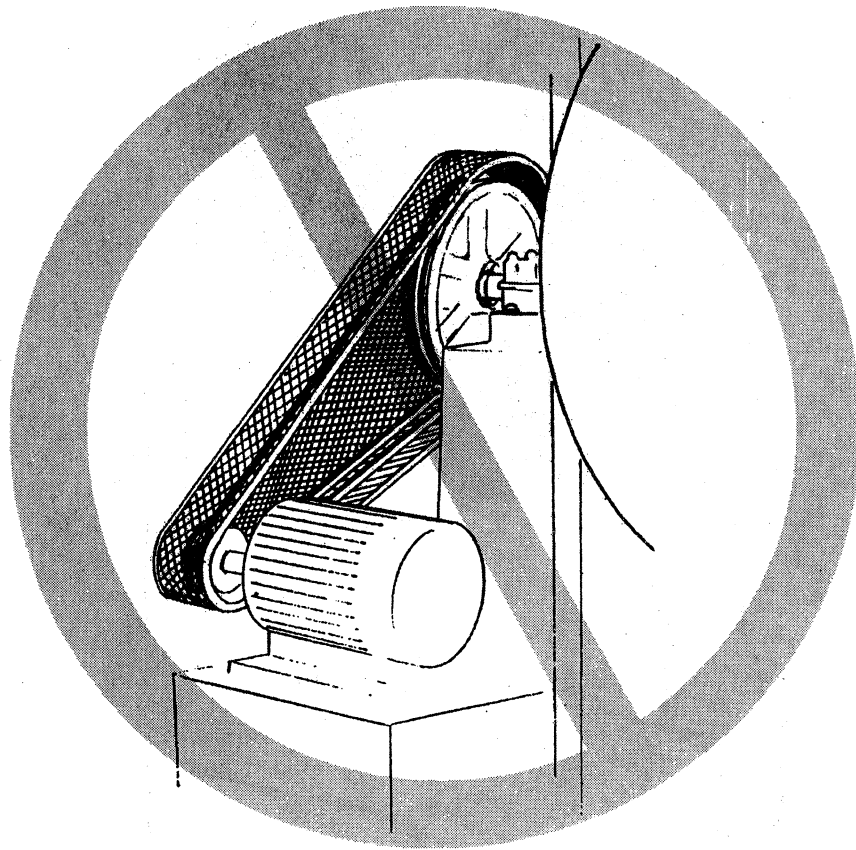

Figure 18

Figure 19 shows an unacceptable guard for a drive belt and pulleys. The belt and pulleys can still be contacted by a miner.



**Figure 19**

Where contact with belts, pulleys, sprockets, chains, etc., is possible from both sides, they must be guarded to prevent contact from either side. An example is shown in Figure 20.

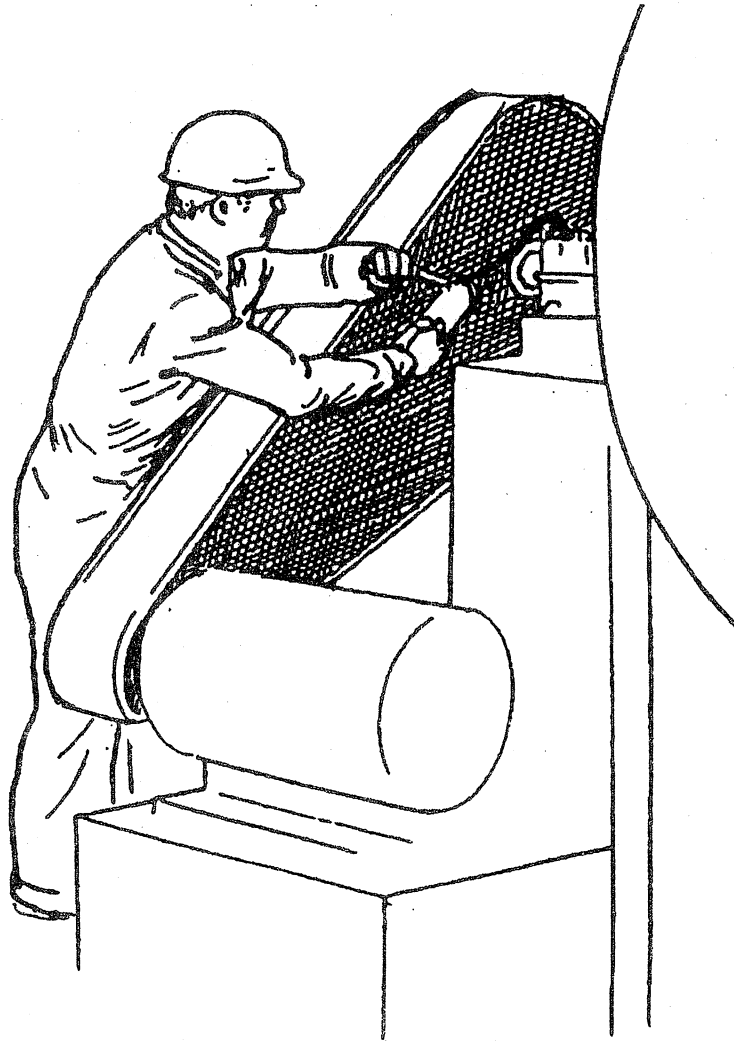
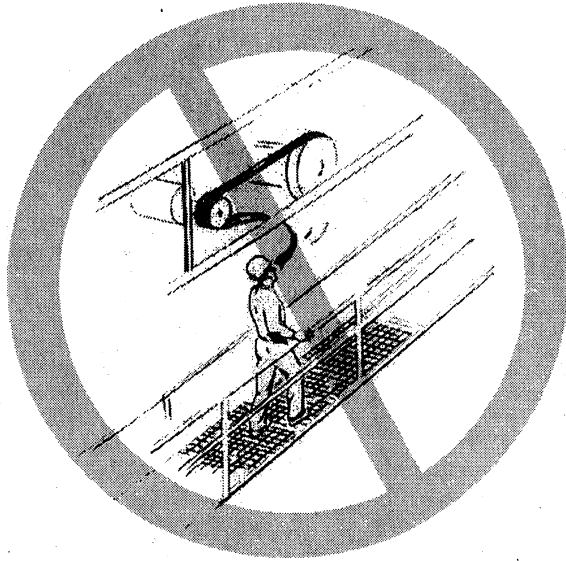
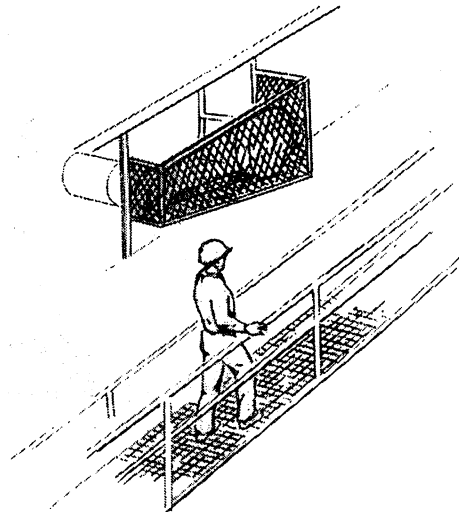

Figure 20

Where hazards are created by belt breakage (Figure 21), a guard must be provided to contain the broken belt. An example is shown in Figure 22.



**Figure 21**



**Figure 22**

Fan blades need to be guarded where they can be contacted (Figure 23).

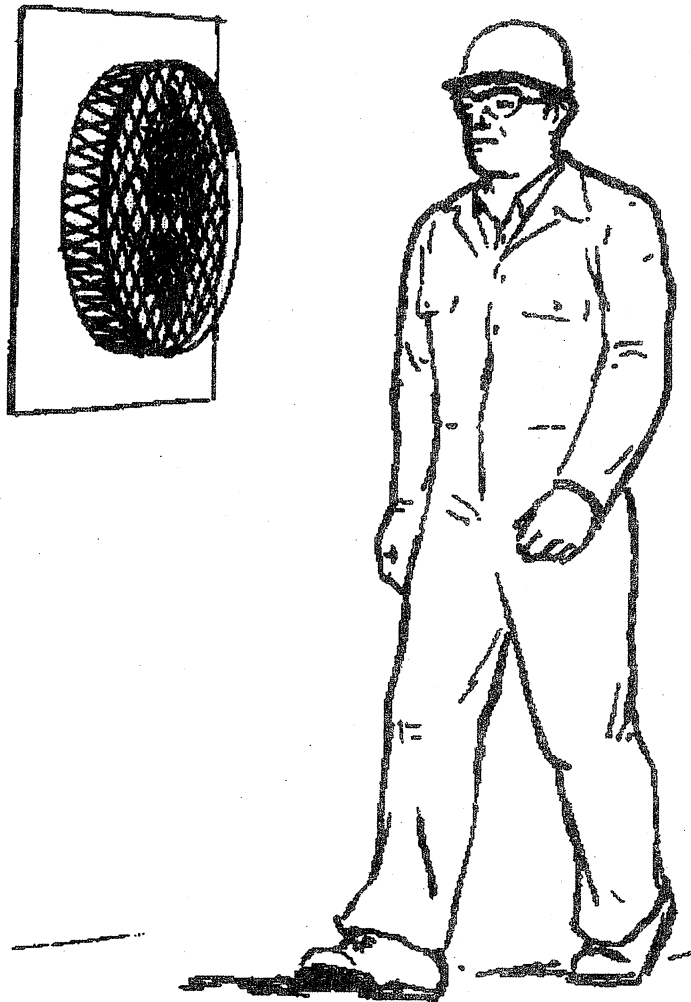
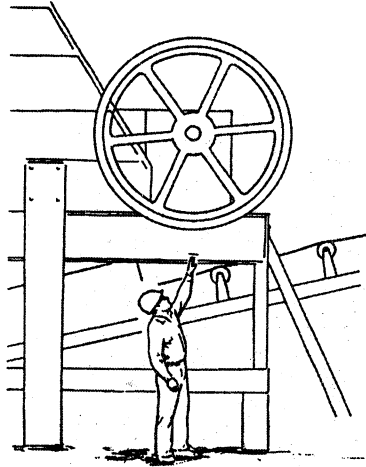
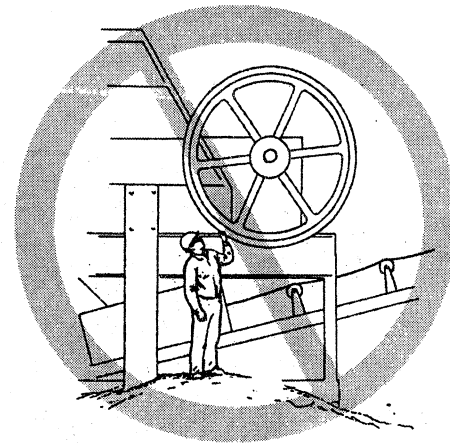

Figure 23

Figure 24 shows a flywheel guarded by location. Buildup of material may place the flywheel within easy reach, as shown in Figure 25. To protect miners from contacting the flywheel, the buildup must be removed or the flywheel must be guarded. An example guard is shown in Figure 26.



**Figure 24**



**Figure 25**

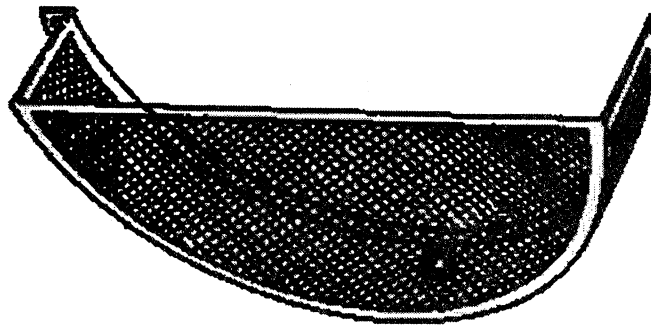

**Figure 26**



Figure 27 is an example of two separately controlled conveyors that are protected by a single guard. In this case a single guard covers the pinch points and moving machine parts of both belt conveyors. Before removing this guard, both belts would need to be secured.

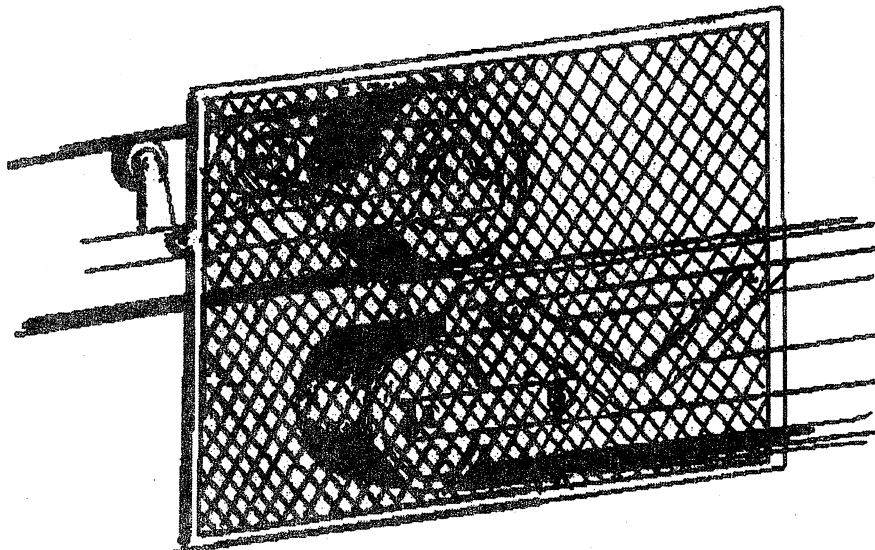

Figure 27

Moving machine parts on mobile equipment may need to be guarded to prevent contact. For example, Figure 28 shows a guard provided to prevent contact with the cooling fan, alternator, and fan belts of a front-end loader. In cases where moving machine parts are located under hoods, behind doors, guarded by location and/or covered by maintenance panels, additional guarding may not be necessary.

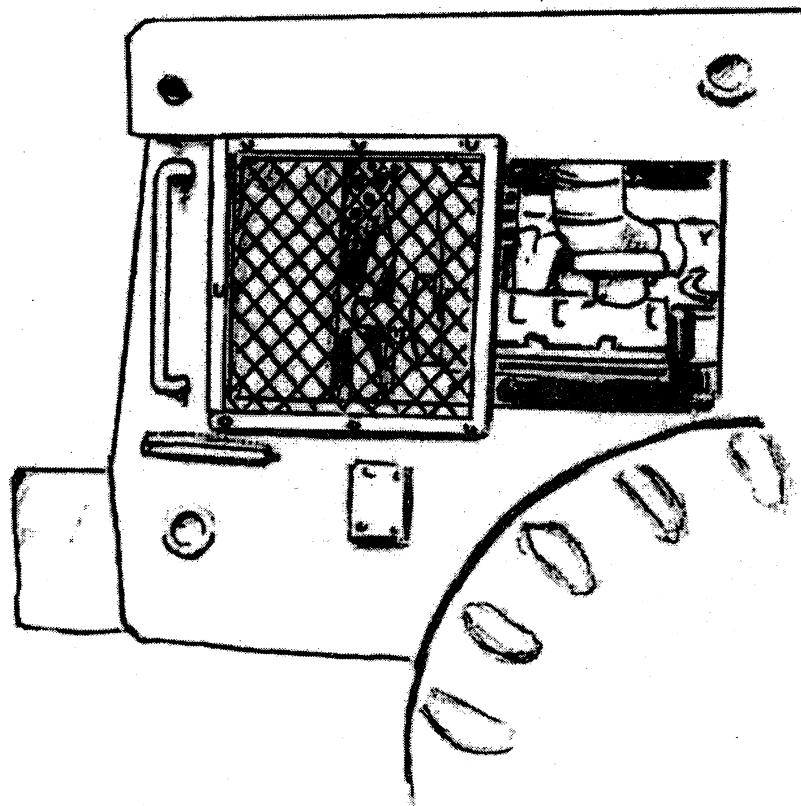

Figure 28

Figure 29 shows a kiln with a railing restricting access to the trunnion area. This railing is unacceptable as a guard because miners access the area beyond the railing while the kiln is in operation. The rotating trunnions are exposed, presenting a hazard to miners.

The railing is not easily recognizable as a guard, is easily defeated, and does not secure the area from entry.

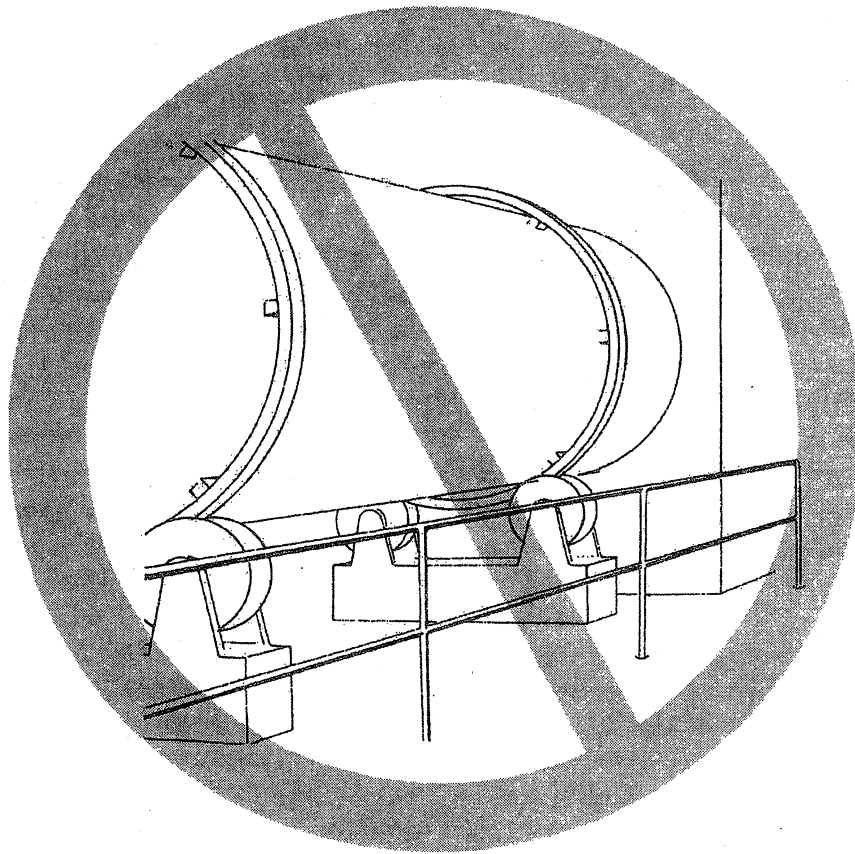
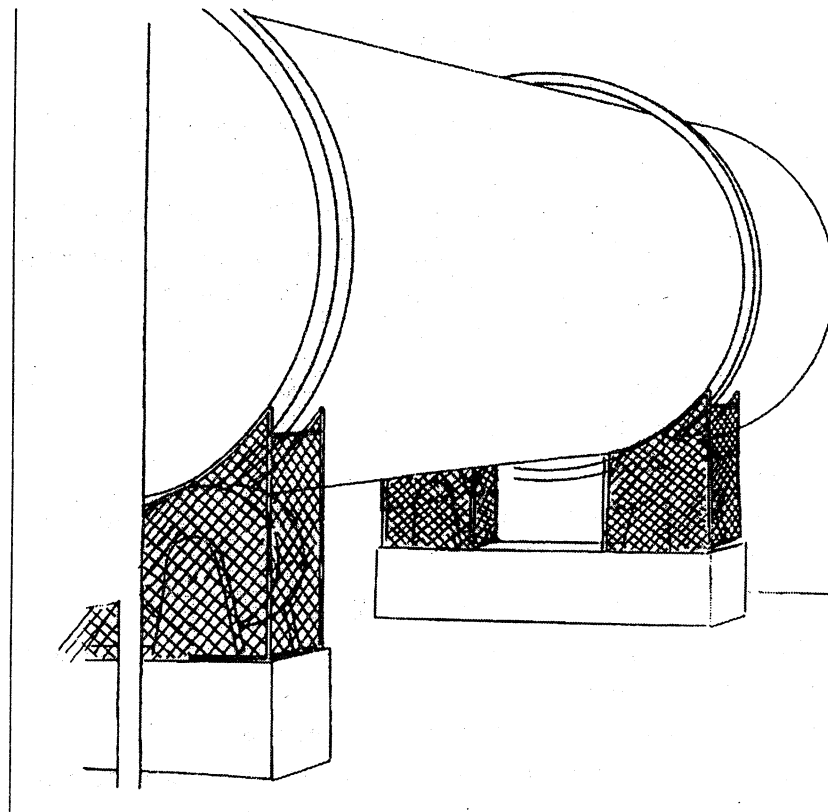

Figure 29

Figure 30 shows the trunnions with point-of-contact guards. This method of guarding permits easy access, yet protects against contacting the moving machine parts. If the lubricating system is accessible with the guard in place, servicing can be done while the kiln is in motion.



**Figure 30**

## AREA GUARDING

An area guard is a barrier which prevents entry of a miner into an area containing moving machine parts, thus preventing contact with the moving parts. Effective area guards may require additional practices and provisions such as signage, locks, color coding, etc., in addition to the physical barrier. When designing, installing, and/or using area guards, consider:

- Security of the area
  - Is the area guard difficult to defeat?
  - Is it locked or bolted?
  - Does the guard prevent entry into the area and is the guard difficult to defeat?
- How will the moving machine parts be shut down before entry?
  - Will the guard be interlocked with the hazardous equipment so entry will automatically shut down the moving parts?
  - Will manual shutdown be used?
- Is the area guard easily recognized as a guard?
  - Are warning signs or color coding in use?
- Frequency of entry into the guarded area
  - Frequently accessed areas may not be suitable for area guarding
- Number of people requiring access into guarded area
  - If a large number of people need access to an area, then area guarding may not be suitable.
  - Education and training in proper procedures
  - Does the work force understand who may enter area guards?
  - Have lock-out, tag-out procedures been addressed?

Figure 31 shows an example of an area guard used to prevent contact with multiple belt tailpieces. Figure 32 shows a similar situation using point-of-contact guards.

An advantage of the area guard is that it may be less expensive. A disadvantage is that both belts need to be locked-out and tagged-out before entering the guarded area.

The advantages of the point-of-contact guards are that one belt can be maintained while the other belt continues to run, the belts can be cleaned around without lock-out/tag-out, and maintenance on the chutes is possible without lock-out/tag-out.

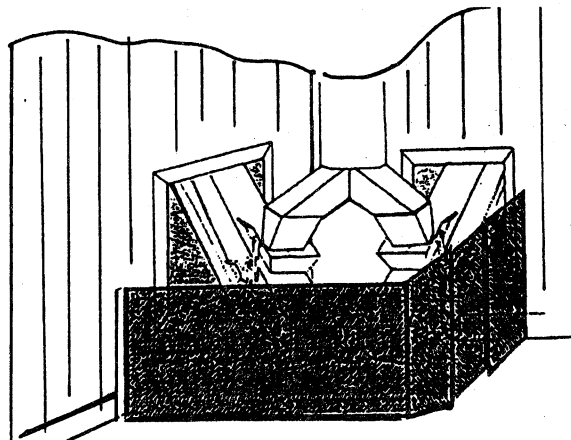

**Figure 31**

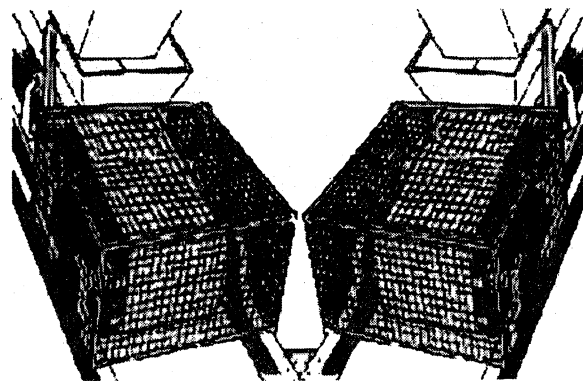

**Figure 32**

The example guard designs shown in Figures 33 and 34 protect the miner from contacting the pinch points, the moving machine parts of the head pulley, and the moving shafts and drive pulleys and belts.

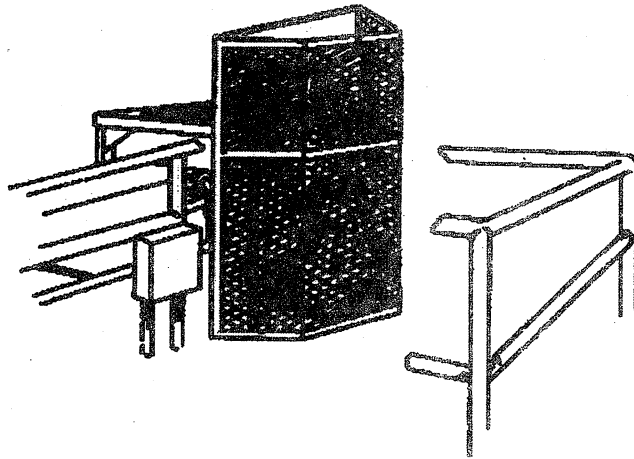

Figure 33

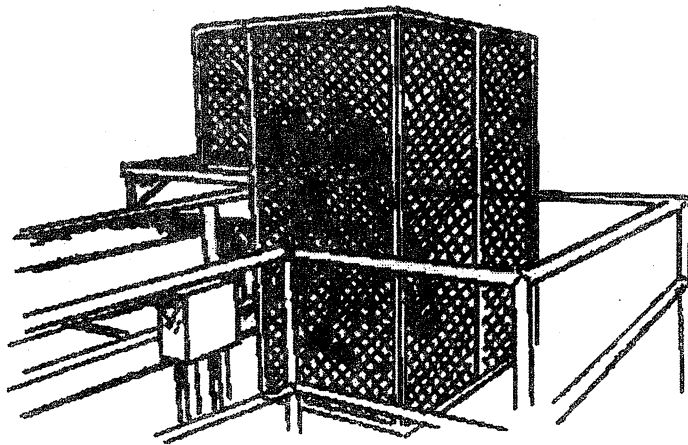
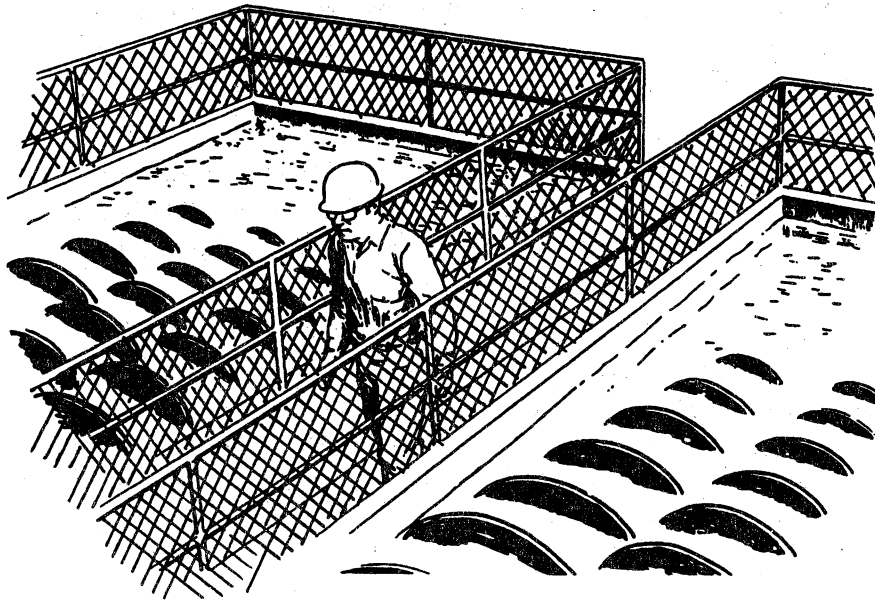

Figure 34

Figure 35 shows classifiers guarded to prevent persons from coming in contact with the screws. This guard adequately protects the miner because it is tall enough and far enough from the hazard to prevent contact during work-related activities.



**Figure 35**



## New Technology

New technologies may provide alternative means of guarding. As new technologies are developed and alternative ways of protecting miners become available, their use and application may provide a level of protection equal to, or surpassing, conventional guards.

Several new technologies show promise:

- ✓ Laser beams may be effective at long range. They can monitor area perimeters and detect when entry into a hazardous area occurs.
- ✓ Pulsed infrared light curtain systems may be useful as area guards. They are particularly useful in dusty environments.
- ✓ Infrared scanners can detect changes in the reflective field of a monitored area.
- ✓ Pressure plates can be equipped with sensors that detect changes in a radio frequency field or electrical capacitance. They can guard an area by sensing a person's approach through contact with the plate.
- ✓ Mechanical pressure mats open electrical contacts to stop a motor when someone steps on the mat in a hazardous area.
- ✓ Interlock systems are available with multiple contacts. Multiple contacts or zones can be used to trigger a warning alarm for entry into an area but shut a system down if the person continues past the warning and approaches a hazard too closely.

While new technologies may be suitable in some situations, you should also be aware of the pitfalls in systems that use these alternative guarding systems. The following types of questions should be asked:

- Does the system react quickly and at sufficient distance to prevent contact with the machine parts before their motion has stopped?
- Is the system redundant?
- Can it be by-passed, such as ducking under a laser beam?
- Is there regular and frequent testing?
- Will the system fail safe?

# REMEMBER

The best guard will not protect miners if it is not properly installed and maintained.

